

BN17 IP65 Specifications

Inside Rotor
Brushless Motors

BN17 IP65 SPECIFICATIONS - Continuous Stall Torque 11.0 to 21.0 oz-in (.078 - .148 Nm) Peak Torque 21 - 66 oz-in (.148 - .466 Nm)

Part Number*		BN17-15IP- <input type="checkbox"/> <input type="checkbox"/> <input type="checkbox"/> <input type="checkbox"/> <input type="checkbox"/> <input type="checkbox"/>			BN17-20IP- <input type="checkbox"/> <input type="checkbox"/> <input type="checkbox"/> <input type="checkbox"/> <input type="checkbox"/> <input type="checkbox"/>			BN17-25IP- <input type="checkbox"/> <input type="checkbox"/> <input type="checkbox"/> <input type="checkbox"/> <input type="checkbox"/> <input type="checkbox"/>		
Winding Code**		01	02	03	01	02	03	01	02	03
L = Length	inches	2.06			2.56			3.06		
	millimeters	52.32			65.02			77.72		
Terminal Voltage	volts DC	12	24	36	12	24	36	12	24	36
Peak Torque	oz-in	22	21	21	45	45	45	66	65	65
	Nm	0.155	0.148	0.148	0.318	0.318	0.318	0.466	0.459	0.459
Continuous Stall Torque	oz-in	11	11	12	17	18	19	19	20	21
	Nm	0.078	0.078	0.085	0.120	0.127	0.134	0.134	0.141	0.148
No-Load Speed	RPM	12,322	16,830	16,290	10,185	10,484	11,084	9,554	9,582	9,000
Rated Speed	RPM	8037	13,498	12,945	5568	7131	7937	5535	6908	6344
	rad/sec	841	1413	1355	583	747	831	580	723	664
Rated Torque	oz-in	9.22	8.2	9.25	14.85	16.01	16.5	16.15	15.1	17.81
	Nm	0.065	0.058	0.065	0.105	0.113	0.117	0.114	0.107	0.126
Rated Current	Amps	8.38	4.71	3.33	10.6	5.31	3.78	11.29	5.57	3.62
Rated Power	watts	55	82	89	61	84	97	66	77	84
Torque Sensitivity	oz-in/amp	1.29	1.83	2.9	1.54	3.05	4.34	1.68	3.32	5.33
	Nm/amp	0.009	0.013	0.020	0.011	0.022	0.031	0.012	0.023	0.038
Back EMF	volts/KRPM	0.95	1.35	2.14	1.14	2.26	3.21	1.24	2.45	3.94
	volts/rad/sec	0.009	0.013	0.020	0.011	0.022	0.031	0.012	0.023	0.038
Terminal Resistance	ohms	0.228	0.531	1.150	0.206	0.672	1.277	0.194	0.594	1.414
Terminal Inductance	mH	0.201	0.437	1.100	0.178	0.437	1.466	0.168	0.648	1.661
Motor Constant	oz-in/sq.rt.watt	2.70	2.51	2.70	3.39	3.72	3.84	3.81	4.31	4.48
	Nm/sq.rt.watt	0.019	0.018	0.019	0.024	0.026	0.027	0.027	0.030	0.032
Rotor Inertia	oz-in-sec ² x10 ⁻³	0.26	0.26	0.26	0.4	0.4	0.4	0.48	0.48	0.48
	g-cm ²	18.41	18.41	18.41	28.33	28.33	28.33	33.99	33.99	33.99
Weight	oz	7	7	7	10.4	10.4	10.3	13.7	13.6	13.7
	g	198	198	198	294	294	291	388	385	388
# of Poles		4	4	4	4	4	4	4	4	4
Timing		120°	120°	120°	120°	120°	120°	120°	120°	120°
Mech. Time Constant	ms	21.3	16	16	18.1	14.5	14.5	19.1	18.6	13.1
Electrical Time Constant	ms	0.20	0.18	0.67	0.18	0.42	0.61	0.40	0.98	0.90
Thermal Resistivity	deg. C/watt	2.95	3.95	3.93	1.86	2.86	3.14	1.77	2.18	2.64
Speed/Torque Gradient	rpm/oz-in	465	406	362	311	210	191	249	177	149

Notes:

- Motor mounted to a 4 x 4 x 1/4 inches aluminum plate, still air.
- Maximum winding temperature of 155°C.
- Typical electrical specifications at 25°C.
- Motor Terminal Voltages are representative only; motors may be operated at voltages other than those listed in the table. For assistance please contact our applications engineer.
- For MS (military style) connector, please specify connector housing and terminal.
- Data for informational purposes only. Should not be considered a binding performance agreement. For specific applications, please contact the factory.

*Many other custom mechanical options are available – consult factory.

**Many other winding options are available – consult factory.

Select your options below and place their code in its corresponding block as shown on page 5.

- | | | |
|--|---|--|
| <input checked="" type="checkbox"/> TERMINATION | <input checked="" type="checkbox"/> FEEDBACK OPTIONS | <input checked="" type="checkbox"/> OTHER OPTIONS |
| L – Leads (std) | H – Hall Effect (std) | D – Drive |
| C – Connector | | G – Gearhead |
| M – MS connector | | |

BN17 IP65 Housed / Frameless

Inside Rotor
Brushless Motors

BN17 IP65 Typical Outline - Housed

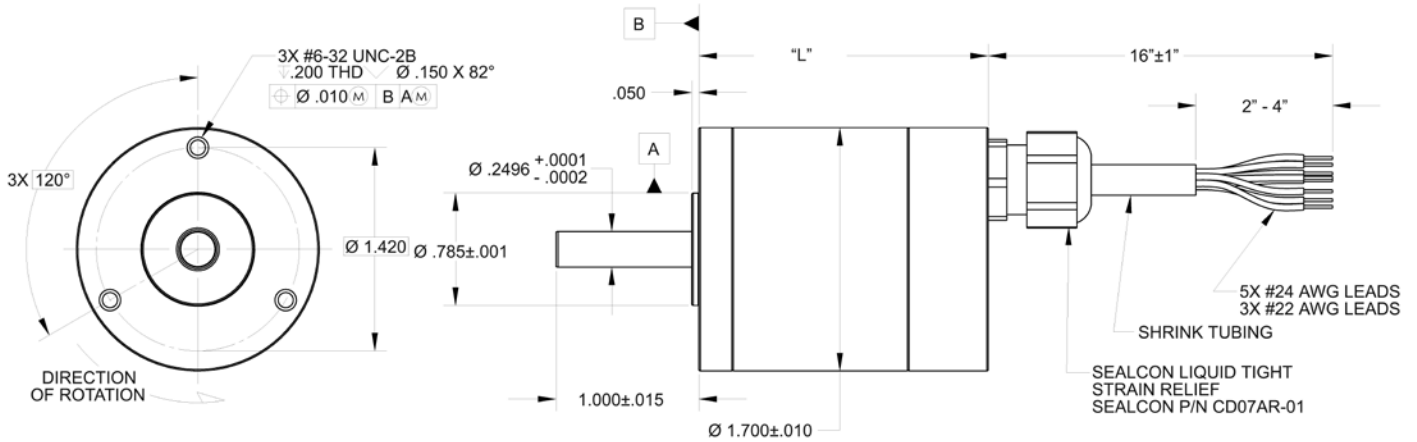

Dimensions are in inches

BN17 IP65 Typical Outline - Frameless

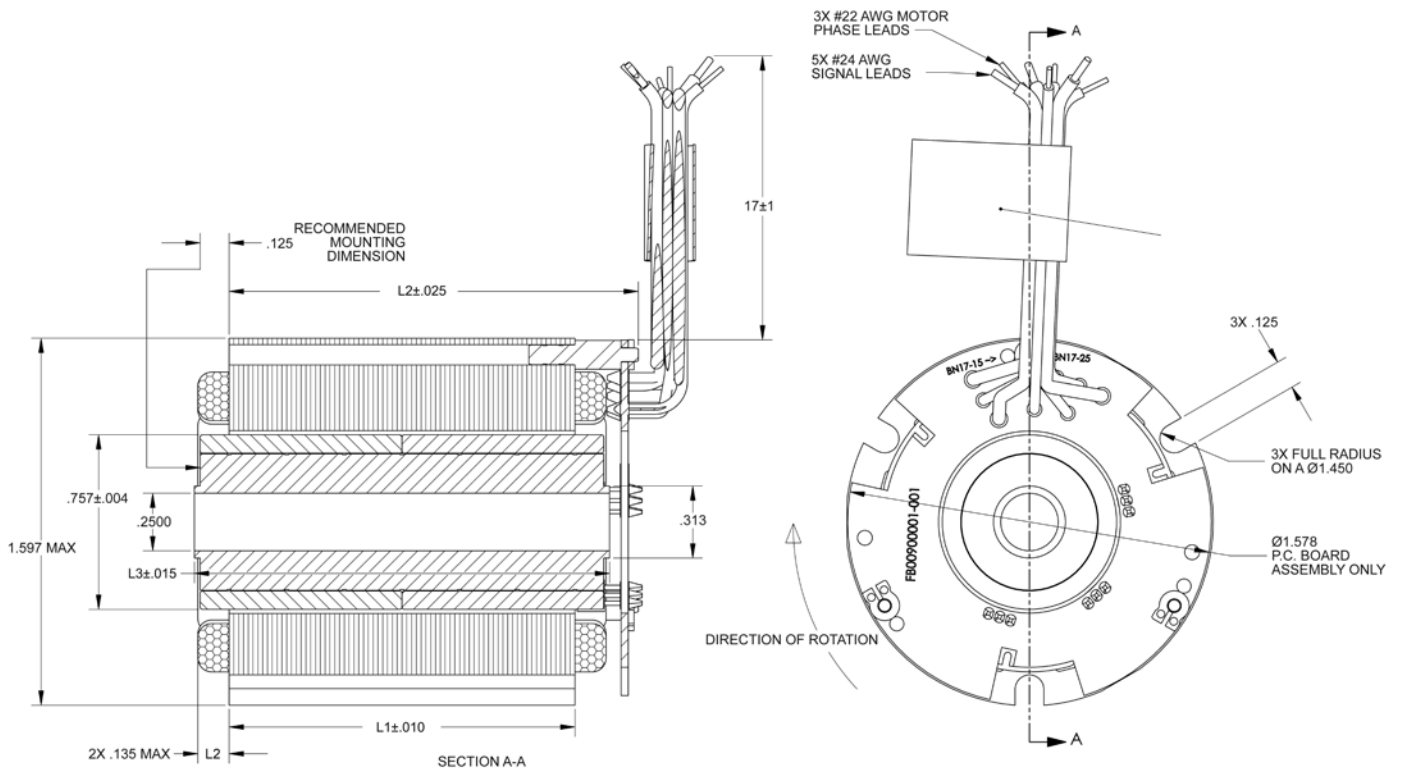

Dimensions are in inches

Termination Table

PIN COLOR	CONNECTION
YELLOW	V _{CC}
GRAY	GROUND
BROWN	S1 OUT
BLUE	S2 OUT
ORANGE	S3 OUT
RED	A COIL
BLACK	B COIL
GREEN	C COIL

PART NUMBER	L1	L2	L3
BN17-15ZA-XXLH	0.500	0.780	0.800
BN17-20ZA-XXLH	1.000	1.280	1.300
BN17-25ZA-XXLH	1.500	1.780	1.800

Note: For electrical performance see page 14.

BN17 IP65 Performance Curves

Inside Rotor
Brushless Motors

BN17 IP65 Performance Curves

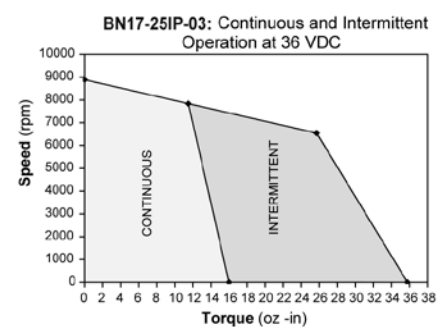
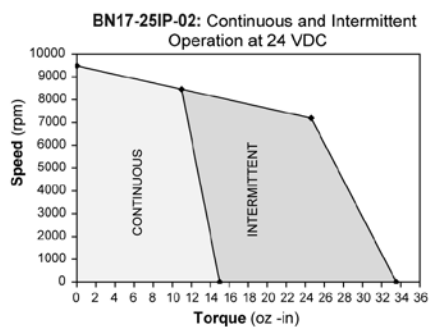
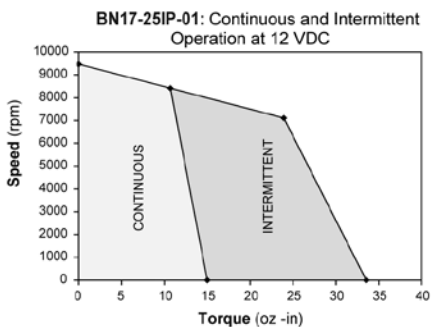
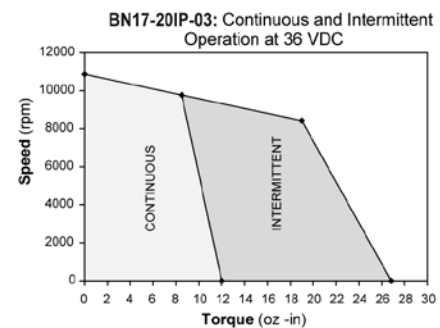
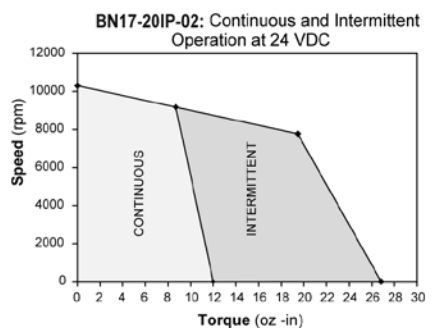
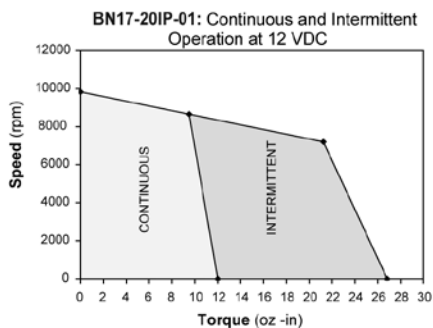
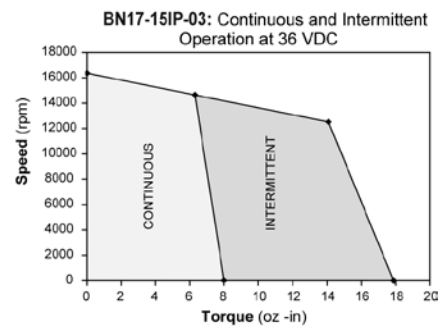
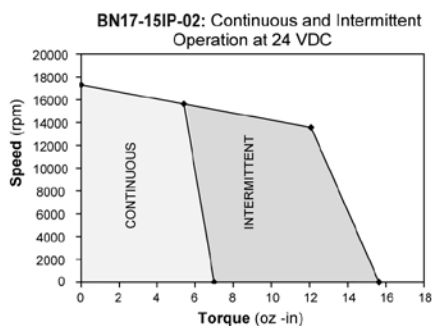
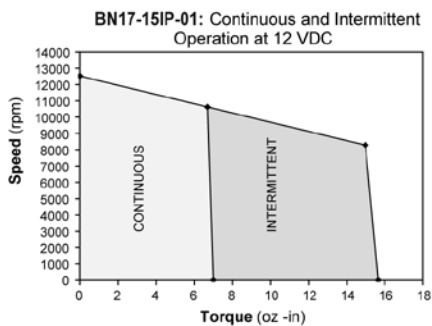

Note: Intermittent operation is based on a 20% duty cycle of one minute on, four minutes off. Please contact the factory regarding the duty cycle of your application.